

English version

Ventilation for buildings - Air handling units - Ratings and performance for units, components and sections

Ventilation des bâtiments - Caissons de traitement d'air -
Classification et performance des unités, composants et
sections

Lüftung von Gebäuden - Zentrale raumluftechnische
Geräte - Leistungskenndaten für Geräte, Komponenten und
Baueinheiten

This draft European Standard is submitted to CEN members for enquiry. It has been drawn up by the Technical Committee CEN/TC 156.

If this draft becomes a European Standard, CEN members are bound to comply with the CEN/CENELEC Internal Regulations which stipulate the conditions for giving this European Standard the status of a national standard without any alteration.

This draft European Standard was established by CEN in three official versions (English, French, German). A version in any other language made by translation under the responsibility of a CEN member into its own language and notified to the Management Centre has the same status as the official versions.

CEN members are the national standards bodies of Austria, Belgium, Czech Republic, Denmark, Finland, France, Germany, Greece, Hungary, Iceland, Ireland, Italy, Luxembourg, Malta, Netherlands, Norway, Portugal, Slovakia, Spain, Sweden, Switzerland and United Kingdom.

Warning : This document is not a European Standard. It is distributed for review and comments. It is subject to change without notice and shall not be referred to as a European Standard.



EUROPEAN COMMITTEE FOR STANDARDIZATION
COMITÉ EUROPÉEN DE NORMALISATION
EUROPÄISCHES KOMITEE FÜR NORMUNG

Management Centre: rue de Stassart, 36 B-1050 Brussels

Contents

Foreword.....	3
1 Scope	4
2 Normative references	4
3 Terms and definitions	5
4 Symbols and abbreviations	8
5 Ratings and performance of the whole air handling unit	10
5.1 General.....	10
5.2 Testing of aerodynamic performance	10
5.3 Testing of acoustic performance	14
5.4 Tolerances	17
5.5 Test report	18
6 Components and sections in air-handling units	21
6.1 General.....	21
6.2 Casing	21
6.3 Fan section	23
6.4 Coils	24
6.5 Heat recovery sections	25
6.6 Damper sections	27
6.7 Mixing sections	27
6.8 Humidifiers	31
6.9 Filter sections.....	34
6.10 Sound attenuation sections.....	36
7 Extended hygiene requirements for special applications	36
7.1 General.....	36
7.2 Accessibility	36
7.3 Smoothness	36
7.4 Inspection windows and lights.....	36
7.5 Drainage/prevention of condensation, humidifiers.....	37
7.6 Air leakage.....	37
8 Instructions for installation, operation and maintenance	37
8.1 Installation	37
8.2 Operation and maintenance	37
8.3 Documentation and labelling.....	38
Annex A (normative) Air handling units - Heat recovery – Defrosting - Requirements and testing	39
A.1 General.....	39
A.2 Defrosting	39
A.3 Testing	40
A.4 Test report	42

Foreword

This document (prEN 1886:2003) has been prepared by Technical Committee CEN/TC 156 "Ventilation for buildings", the secretariat of which is held by BSI.

This document is currently submitted to the CEN Enquiry.

This document will supersede EN 13053:2001.

This European Standard is a part of a series of standards for air handling units used for ventilation and air conditioning of buildings for human occupancy. It considers the ratings and the performance of air handling units as a whole, the requirements and performance of specific components and sections of air handling units including hygiene requirements. It is supported by the standard for mechanical performance, EN 1886. The position of this standard in the field of mechanical building services is shown in figure 1.

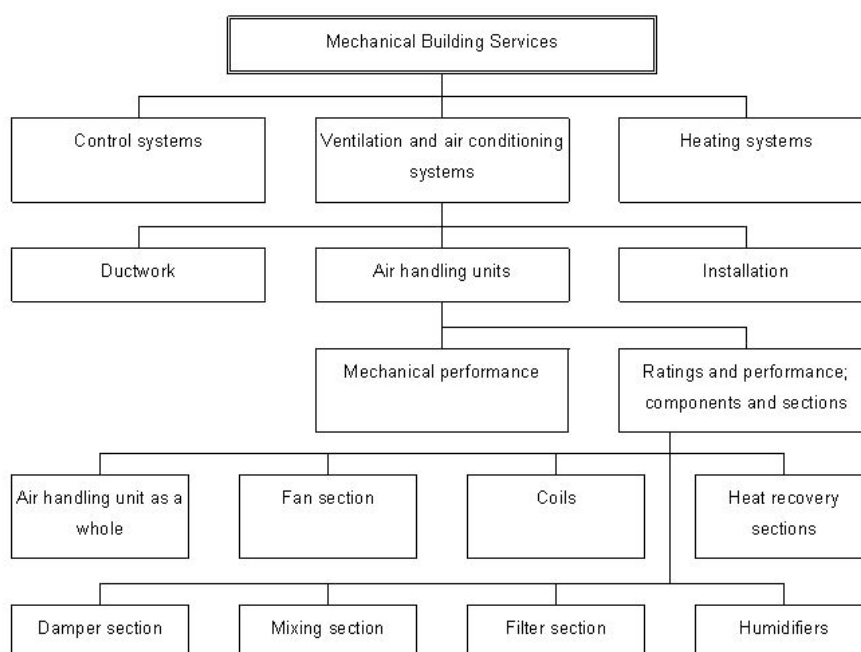

Figure 1 — Position of this standard in the field of mechanical building services

Annex A is normative.

1 Scope

This European Standard specifies requirements and testing for ratings and performance of air handling units as a whole. It also specifies requirements, classification, and testing of specific components and sections of air handling units. For many components and sections it refers to component standards, but it also specifies restrictions or applications of standards developed for standalone components.

This standard is applicable both to standardised designs, which may be in a range of sizes having common construction concepts, and also to custom-design units. It also applies both to air handling units, which are completely prefabricated, and to units which are built up on site. Generally the units within the scope of this standard include at least a fan, a heat exchanger and an air filter.

This standard is not applicable to the following:

- a) air conditioning units serving a limited area in a building, such as fan coil units;
- b) units for domestic ventilation systems;
- c) units producing ventilation air mainly for a manufacturing process.

2 Normative references

This European Standard incorporates by dated or undated reference, provisions from other publications. These normative references are cited at the appropriate places in the text and the publications are listed hereafter. For dated references, subsequent amendments to or revisions of any of these publications apply to this European Standard only when incorporated in it by amendment or revision. For undated references the latest edition of the publication referred to applies.

EN 305, *Heat exchangers — Definitions of performance of heat exchangers and the general test procedure for establishing performance of all heat exchangers*

EN 308, *Heat exchangers — Test procedures for establishing performance of air to air and flue gases heat recovery devices*

EN 779, *Particulate air filters for general ventilation — Requirements, testing, marking*

EN 1216, *Heat exchangers — Forced circulation air-cooling and air-heating coils — Test procedures for establishing the performance*

EN 1751, *Ventilation for buildings — Air terminal devices — Aerodynamic testing of dampers and valves*

EN 1886, *Ventilation for buildings — Air handling units — Mechanical performance*

EN 10088-2, *Stainless steel — Part 2: Technical delivery conditions for sheet/plate and strip for general purposes*

EN 12792, *Ventilation for buildings — Symbols and terminology*

EN 13030, *Ventilation for buildings — Terminals — Performance testing of louvres subjected to simulated rain*

prEN 13779 *Ventilation for non-residential buildings - Performance requirements for ventilation and room-conditioning systems*

EN 25136, *Acoustics — Determination of sound power radiated into a duct by fans — In-duct method (ISO 5136:1990 and Technical Corrigendum 1:1993)*

EN ISO 3741, *Acoustics — Determination of sound power levels of noise sources using sound pressure — Precision methods for reverberation rooms (ISO 3741:1999)*

EN 60034-2 *Rotating electrical machines. Part 2: Methods for determining losses and efficiency of rotating electrical machinery from tests (excluding machines for traction vehicles)* EN ISO 3744, *Acoustics — Determination of sound power levels of noise sources using sound pressure — Engineering methods in an essentially free field over a reflecting plane (ISO 3744:1994)*

EN ISO 3746, *Acoustics — Determination of sound power levels of noise sources using sound pressure — Survey method using an enveloping measurement surface over a reflecting plane (ISO 3746:1995)*

EN ISO 7235, *Acoustics — Measurement procedures for ducted silencers — Insertion loss, flow noise and total pressure loss (ISO 7235:1991)*

EN ISO 9614-1, *Acoustics — Determination of sound power levels of noise sources using sound intensity — Part 1: Measurement at discrete points (ISO 9614-1:1993)*

EN ISO 9614-2, *Acoustics — Determination of sound power levels of noise sources using sound intensity — Part 2: Measurement by scanning (ISO 9614-2:1996)*

prEN ISO 9614-3:2000, *Acoustics — Determination of sound power levels of noise sources using sound intensity — Part 3: Precision method for measurement by scanning (ISO/DIS 9614-3:2000)*

ISO 3966, *Measurement of fluid flow in closed conduits — Velocity area method using pitot-static tubes*

ISO 5167-1, *Measurement of fluid flow by means of pressure differential devices — Part 1: Orifice plates, nozzles and Venturi tubes inserted in circular cross-section conduits running full*

ISO/TR 5168, *Measurement of fluid flow — Evaluation of uncertainties.*

ISO 5221, *Air distribution and air diffusion — Rules to methods of measuring air flow rate in an air-handling duct*

ISO 5801:1997, *Industrial fans — Performance testing using standardized airways*

3 Terms and definitions

For the purposes of this European Standard, the terms and definitions given in EN 12792 and the following apply.

3.1

air handling unit

factory made encased assembly consisting of sections containing a fan or fans and other necessary equipment to perform one or more of the following functions: circulating, filtration, heating, cooling, heat recovery, humidifying, dehumidifying and mixing of air

3.2

section of air handling unit

functional element of an air-handling unit, consisting of one or more components in a single casing

3.3

component of air handling unit

smallest functional element of an air-handling unit

3.4

blow-through unit

air handling unit with a section or sections downstream of the supply air fan

3.5

casing of an air-handling unit

enclosure of the unit, within which the components are mounted

3.6

openings for outdoor air, supply air, extract air, recirculation air and exhaust air

aperture through which air is taken in or discharged from the air-handling unit, such as openings for outdoor air, supply air, recirculation air and exhaust air

3.7

damper section

section of air handling unit including a damper or valve

3.8

mixing section

section where e.g. outdoor air flow and the recirculation air flow are mixed in a controlled way. The section generally consists of one damper per air flow and a mixing chamber

3.9

filter section

section including a filter or filters and associated filterframe

prEN 13053:2003 (E)

3.10

heat recovery section

section in which heat (and possibly also moisture) is transferred from one airstream into another, either directly or using an intermediary heat transfer medium

3.11

air heating and cooling coils

heat exchangers by means of which heat is transferred from a heat transfer medium to air (heating coil) or the other way round (cooling coil)

3.12

sound attenuation section

section in which sound transfer into ductwork or to ambient air is reduced

3.13

humidifier section

section in which moisture is added to the air

3.14

fan section

section in which one or more fans are installed for air moving

3.15

combined section

section within which two or more functions are combined

3.16

functions

3.16.1

air treatment

process by which the state of the air is modified with respect to one or more of its characteristics such as temperature, moisture content, dust content, bacterial count, gas and vapour contents

3.16.2

air type

designation of the air moving through a ventilation, air conditioning or air treatment installation as a function of its location relative to the installation, e.g. outdoor air, exhaust air, extract air etc

3.16.3

cooling

removal of latent and/or sensible heat

3.16.4

dehumidification

controlled reduction of water vapour from the air

3.16.5

filtration

removal of particulate material from the airstream

3.16.6

heating

transfer of heat from one body or medium to another medium

3.16.7

humidification

controlled addition of water vapour to an air stream or space

3.16.8

sound reduction

controlled reduction of sound energy

3.17 characteristics

3.17.1 air flow

movement of air within set boundaries (such as ducts)

3.17.2 air flow rate

mass or volume flow of air passing a given plane divided by time

3.17.3 bypass factor

ratio of the diverted flow to the sum of the main flow and the diverted flow

3.17.4 bypass leakage

unwanted and uncontrolled passing of untreated air into the treated air between the components within a casing, such as filters and coils

3.17.5 deflection of a casing [see: bulging, caving]

deformation in mm of the external surfaces of the enclosure when subjected to a positive (bulging) or negative (caving) pressure. It is given as the measured difference in distance between a reference plane and the maximum point of deflection when subjected to air pressure

3.17.6 defrosting heat ratio

ratio between the energy transferred into the supply air and the maximum recoverable energy in exhaust air, excluding the energy input for defrosting

3.17.7 air leakage factor f

air tightness expressed as the air leakage per unit envelope area and pressure difference (external air leakage)

3.17.8 air leakage rate q_{vl}

air leakage of the air handling unit, subject to air pressure (external air leakage)

3.17.9 external total pressure difference

difference between the total pressure at the outlet of the air handling unit and the total pressure at the inlet

3.17.10 humidification efficiency

ratio between the mass of water evaporated by the humidifier and the theoretical mass needed to achieve saturation at a given temperature

3.17.11 internal air leakage rate

air leakage in between the two air streams within a section

3.17.12 thermal bridging factor k_b

ratio between the lowest temperature difference between any point on the external surface and the mean internal air temperature, and the mean air to air temperature difference

3.17.13 thermal transmittance U

heat flow per unit of area and temperature difference

4 Symbols and abbreviations

For the purposes of this standard, symbols and units given in EN 12792 and in table 1 apply, together with those defined with the formulae, in text and in the annexes of this standard.

Table 1 — Symbols, terms, units and subscripts

Symbol	Term	Unit
A	Surface area	m^2
A_c	Cross sectional area of a duct	m^2
c	sound velocity in the air	$\text{m} \times \text{s}^{-1}$
d	effective duct diameter	m
D_p	sound insertion loss	dB
E	Duct end correction value	dB
f	air leakage factor	$\text{l} \times (\text{s} \times \text{m}^2)^{-1}$
k	number of measurements within the total measuring time	-
k	filter bypass leakage factor	%
k_b	thermal bridging factor of the casing	-
L_p	sound pressure level	dB
L_W	sound power level	dB
L_{WA}	A-weighted sound power level	dB(A)
n_F	rotational speed of the fan	s^{-1}
P_E	Electrical motor input power	W
p_a	atmospheric pressure	Pa
p_d	dynamic pressure	Pa
p_s	static pressure	Pa
p_t	total fan pressure	Pa
p_{tu}	external total pressure difference of the unit	Pa
Q_{defr}	total energy input for defrosting during one complete frosting/defrosting cycle	J
p_v	partial pressure of water vapour	Pa
q_{mn}	nominal air mass flow rate of the recovery device	$\text{kg} \times \text{s}^{-1}$
q_m	air mass flow rate	$\text{kg} \times \text{s}^{-1}$
q_v	air volume flow rate	$\text{m}^3 \times \text{s}^{-1}$

Table 1 (continued)

Symbol	Term	Unit
q_{vm}	measured and converted air volume flow rate	$m^3 \times s^{-1}$
q_{vs}	specified air volume flow rate	$m^3 \times s^{-1}$
t_a	dry-bulb temperature	$^{\circ}C$
$t_{m,i}$	local temperature at measurement point	$^{\circ}C$
t_i	mean internal air temperature	$^{\circ}C$
t	tolerance range	%
u	uncertainty range of measured data	%
U	range of uniformity of flow after the mixing section	-
U	thermal transmittance of the casing	$W \cdot m^2 \times K^{-1}$
v	velocity of air at a point	$m \times s^{-1}$
x	absolute humidity	$g \times kg^{-1}$
$\Delta\tau$	sampling interval time	s
Δp_1	pressure drop on exhaust-air side	Pa
ε_D	defrosting heat ratio	-
η_h	humidifier efficiency	-
η_{mix}	mixing efficiency	%
φ	relative humidity	%
ρ	density	$kg \times m^{-3}$
Subscripts		
1	inlet	
2	outlet	
11	exhaust air in	
12	exhaust air out	
21	supply air in	
22	supply air out	
i	internal	
H	air flow with higher temperature	
L	air flow with lower temperature	

Table 1 (concluded)

Subscripts	
M	mixed air flow [mean temperature]
tot	air flow downstream of the mixing section
Abbreviations	
HVAC	Heating, ventilation and air conditioning

5 Ratings and performance of the whole air handling unit

5.1 General

The performance of the whole air-handling unit cannot be defined as a sum of those of the individual components and sections. Hence, the procedures that follow shall be applied to a complete air-handling unit. In particular and agreed circumstances they can be applied to a part of an air-handling unit.

The methods described in 5.2 cover the measurement of air volume flow together with the external total pressure of the unit and the power consumption. By selecting an appropriate test system the procedures can be extended to include the measurement of sound level transmitted from the air-handling unit into the ductwork, at a known volume flow, as described in 5.3.

5.2 Testing of aerodynamic performance

5.2.1 Characteristics and quantities

5.2.1.1 Characteristics

- External total pressure difference of the unit / Air volume flow - characteristic. The difference in total pressure between outlet and inlet of the air-handling unit, related to the air volume flow at the measurement plane.
- Electrical motor input power / Air volume flow - characteristic. The power input to the fan motor related to the air volume flow.

NOTE. If speed adjustment device is needed, e.g. frequency inverter, the electrical motor input power shall include the power of speed control devices.

These characteristics shall be converted from the ambient temperature and pressure measured at the time of the test to standard conditions with air density of $1,2 \text{ kg} \times \text{m}^{-3}$. The characteristics shall be presented for a stated nominal fan speed but without adjustment for inherent speed deviation during the test.

5.2.1.2 Quantities

- Air volume flow rate (q_v)*. This shall be measured by any method, which is in accordance with ISO 5801, ISO 5221, ISO 5167-1 or ISO 3966, e.g. a nozzle, an orifice plate or a pitot-static tube.
- External total pressure difference of the unit (p_{tu})*. This shall be calculated from the pressure measurements defined in 5.2.3.2, and is the difference between the total pressure at the outlet of the air handling unit and the total pressure at the inlet. The duct sizes shall be the sizes defined by the manufacturer.

NOTE External total pressure difference p_{tu} is defined in terms of the difference in stagnation pressures between outlet and inlet, but the Mach Number applicable to an air handling unit will be sufficiently low (less than 0,15) for total pressures to be determined by conventional means. Hence, external total pressure difference of the unit is:

$$p_{tu} = p_{tu2} - p_{tu1} \quad (1)$$

where

p_{tu} is the sum of the static pressure p_{su} and the dynamic pressure p_{du} , expressed in Pascal (p_{tu2} for outlet, p_{tu1} for inlet).

c) *Density of air* (ρ). This shall be given in $\text{kg} \times \text{m}^{-3}$, by the following expression according to ISO 5801:1997:

$$\rho = \frac{p_a - 0,378 p_v}{287(273 + t_a)} \quad (2)$$

where

p_a is the atmospheric pressure, expressed in Pa;

p_v is the partial pressure of water vapour in the air, expressed in Pa;

287 is the gas constant of dry air, expressed in $\text{J} \times \text{kg}^{-1} \times \text{K}^{-1}$;

t_a is the dry-bulb temperature, expressed in °C.

d) *Temperature of the air* (t_a). This shall be measured.

e) *Rotational speed of the fan* (n_F). This shall be measured.

f) *Electrical motor input power* (P_E). The power to the fan motor shall be measured at each test point. The applied voltage and the current to each phase shall also be recorded when measured.

5.2.2 Test method

5.2.2.1 Basis of method

Tests shall be carried out in accordance with one of the methods shown in ISO 5801. Test installation type B, C or D shall be adopted according to which is most suited to the geometry of the air-handling unit and the facilities available.

The three installation types are as follows:

- installation type B: free inlet, ducted outlet
- installation type C: ducted inlet, free outlet
- installation type D: ducted inlet, ducted outlet

In the above classification the terms shall be taken to have the following meanings:

Free inlet or outlet signifies that the air enters or leaves the air-handling unit directly from or to the unobstructed free atmosphere. Ducted inlet or outlet signifies that the air enters or leaves the unit through a duct directly connected to the unit inlet or outlet respectively.

5.2.2.2 Chamber test method

Where a standardised test chamber is used it shall conform to the requirements of clause 31 of ISO 5801:1997.

5.2.2.3 Ducted test method

The common parts of a ducted system, for Types B, C or D installations, shall conform to the requirements of clause 30 of ISO 5801:1997. The cross-sectional dimensions of the air outlet shall be used to determine the dimensions of the outlet ducting required in a Type B or Type D installation, and the inlet ducting required in a Type C or Type D installation.

5.2.3 Measurement procedure

5.2.3.1 Conditions for measurements

Dampers that control the flow of air in the part of the air-handling unit that is to be tested shall be fully open. Other dampers that form part of a different air circuit, e.g. bypass and recirculation dampers, shall be fully closed.

All elements included in the design of the air handling unit shall be fitted as intended, with filters (average of the measured initial and defined final pressure loss at designed airflow – see 6.9.2) and coils dry.

The average filter pressure drop shall be simulated by using perforated blanking plates mounted for each filter cell.

5.2.3.1.1 Testing of unit with heat recovery

Testing shall be performed in a way to take the leakage between the air streams in consideration.

5.2.3.1.1.1 Testing of complete unit (both air streams)

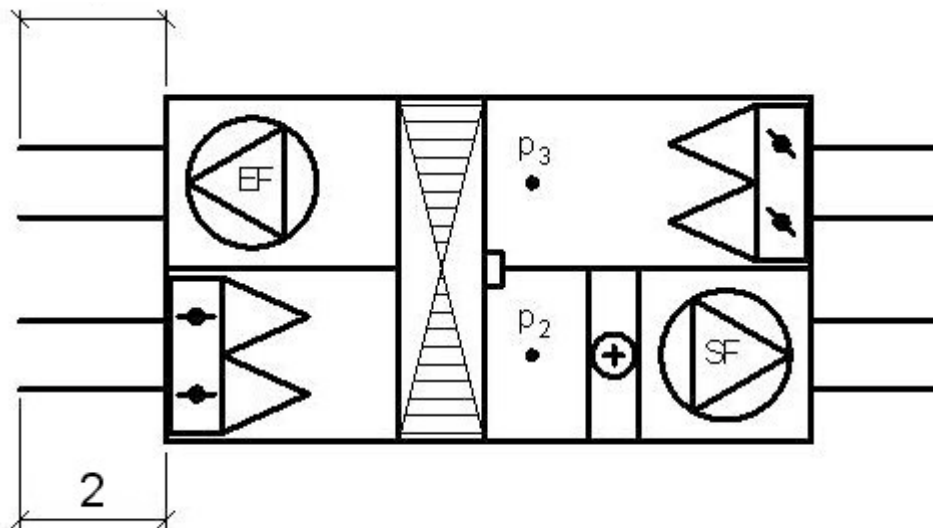

Key

- 1 $\Delta P_{\text{exhaust}}$
- 2 $\Delta P_{\text{outdoor}}$

Figure 2 — Testing of complete unit

The airflow shall be measured at the supply air side and at the extract air side. The external pressures shall be set to design pressure conditions. Unless otherwise stated, the pressure drop on outdoor airside and exhaust airside is set to 50 Pa. The remainder of the external pressures shall be set on the supply and extract air openings. In order to avoid leakages from extract air stream to supply air stream the pressure p_2 should be higher than the pressure p_3 . The two pressures p_2 and p_3 shall be measured. The leakage and the extra pressure drop are the responsibility of the manufacturer.

5.2.3.1.1.2 Testing of one air stream

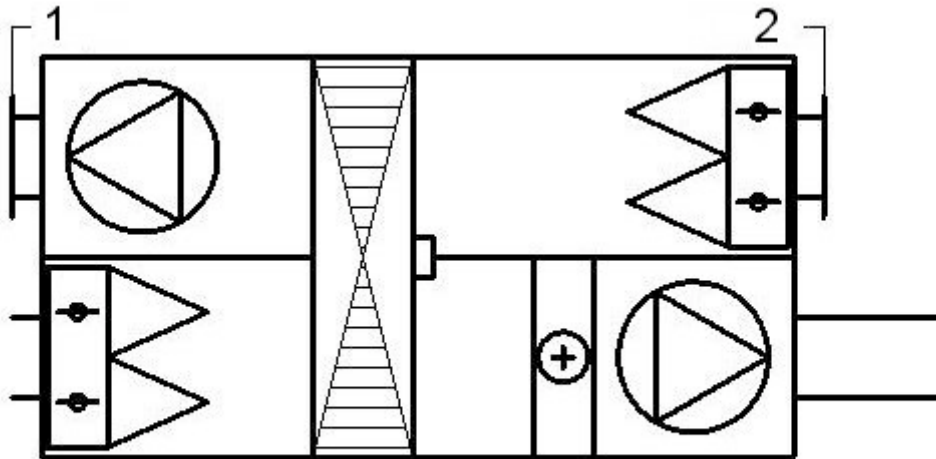

Key

- 1 Inlet Plate
- 2 Outlet Plate

Figure 3 — Testing of one air stream

If just one air stream is to be tested then the connections of the opposite air streams shall be closed with air-tight plates.

5.2.3.2 Measurements

Atmospheric pressure and temperature shall be measured at commencement of the test, additional observations being made if the test is prolonged.

Pressure measurements, at the locations and in the manner described in ISO 5801, shall be recorded at a sufficient number of test points to enable the characteristic curve to be plotted through the specified duty point, or over the full operating range, whichever is required.

Rotational speed of the fan and the electrical input to the fan motor shall be recorded at each of the test points.

5.2.4 Evaluation of results

For each operating point, the external total pressure of the unit and the air volume flow shall be calculated in accordance with ISO 5801. It is sufficient, in most circumstances, to adopt the simplified procedures applicable when the Mach Number is less than 0,15 and the fan pressure ratio less than 1,02 (corresponding to a pressure rise less than 2 000 Pa in ambient air).

The external total pressure and the electrical motor input power described in 5.2.1.1 b) shall be converted to values corresponding to the standard air density of $1,20 \text{ kg} \times \text{m}^{-3}$.

Where the duty specified is for an initial or final filter condition then the external total pressure increase derived from this procedure shall be considered by the calculated pressure difference between the average filter pressure drop and that for the initial or final condition (as appropriate).

5.3 Testing of acoustic performance

5.3.1 General

5.3.1.1 Acoustic tests

5.3.1.1.1 Duct borne noise tests

Measurement of the sound levels transmitted by the unit into the inlet ducting and the outlet ducting shall be conducted in accordance with test methods specified in one of the following:

EN ISO 3741, EN ISO 3744, EN ISO 3746, EN ISO 9614 and EN 25136

5.3.1.1.2 Casing radiated noise test

The casing radiated noise emitted by the complete air-handling unit shall be determined in accordance with one of the following test methods:

EN ISO 3741, EN ISO 3744, EN ISO 3746 and EN ISO 9614

NOTE In the case of air handling units with free inlets or outlets, the casing radiated sound level includes the sound emitted by the free inlet or outlet.

5.3.1.2 Operating point

The air-handling unit shall work at the operating point defined by the air-handling unit manufacturer.

5.3.1.3 Ductwork

The ductworks shall be sized to match the manufacturer's recommended outlet or inlet opening and shall maintain a constant cross section. Ductwork lengths shall be at least 3 effective duct diameters, but not less than 2,6 m.

It is possible that these requirements are not suitable when testing in accordance with EN 25136. In this case the requirements of EN 25136 shall be followed.

5.3.1.4 Air flow conditions

During the measurements the microphone can be exposed to air velocity. A foam microphone windscreen shall be used if the air velocity exceeds $2 \text{ m} \times \text{s}^{-1}$.

For sound test measurements within a room, it is recommended that the ratio between the air flow rate ($\text{m}^3 \times \text{s}^{-1}$) and the room volume (m^3) does not exceed 1/60.

5.3.2 Specific requirements concerning the set-up of acoustic tests

5.3.2.1 Casing radiated noise tests

5.3.2.1.1 Test set-up

The measurement of the sound power level emitted by the air openings and the casing of the unit shall be performed using one of the test set-ups shown in figure 4.

Figures 4a) and 4b) show the set-ups for the measurement using a reverberation room. The measurement shall be performed according to EN ISO 3741.

Figure 4c) shows the set-up for the measurement using the free field method. The measurement shall be performed according to EN ISO 3744 (accuracy class 2), EN ISO 3746 (accuracy class 3) or EN ISO 9614.

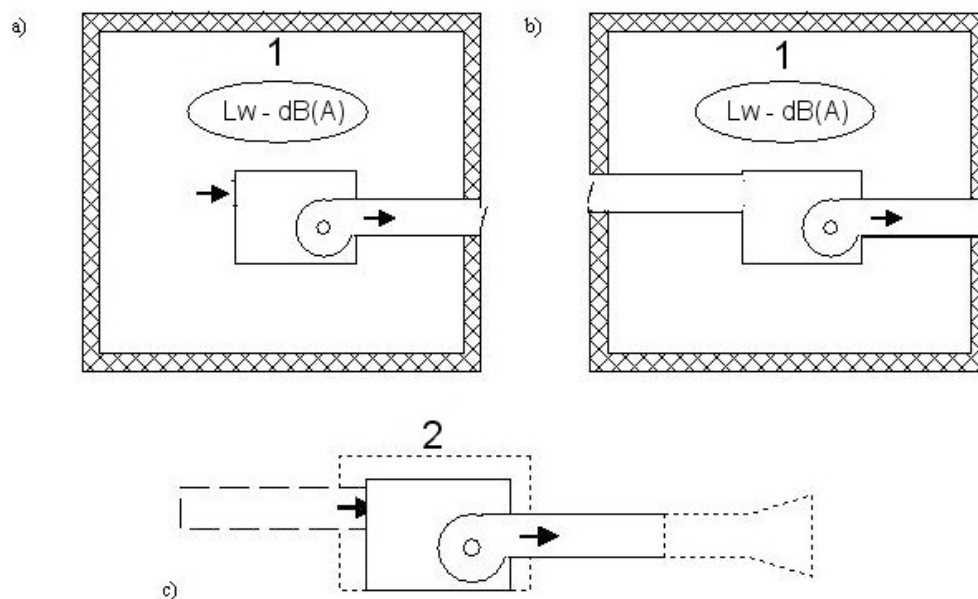

Key

- 1 Reverberation room
- 2 Measuring surface

Figure 4 — Measurement of airborne noise emitted by the air openings and the casing of the unit

5.3.2.1.2 Noise emitted from the ductwork

The ducts shall be of high transmission loss construction to avoid the sound radiation from the ducting contributing to the airborne noise measurements. Confirmation tests shall be conducted to verify that the acoustic contribution from the ductwork is insignificant. For example successive layers of a low absorption acoustical barrier shall be added to the exterior of the ductwork until the resulting sound measurement indicates no change greater than 1 dB on octave bands from the previous sound measurement in the band of interest.

5.3.2.1.3 Throttling device

Where a throttling device is necessary for adjusting the unit to the operating point it shall be placed far away from the casing or outside the room in order to avoid its contribution to the resulting sound power level.

5.3.2.2 Duct borne noise tests

5.3.2.2.1 Test set-up

The measurement of the sound power level transmitted by the unit into the ductwork shall be performed using one of the test set-ups shown in figure 5.

Figure 5a) shows the set-up for the measurement using a reverberation room. The measurement shall be performed according to EN ISO 3741. Duct end correction shall be applied in accordance with 5.3.2.2.4.

Figure 5b) shows the set-up for the measurement using the free field method. The measurement shall be performed according to EN ISO 3744 or EN ISO 9614. Duct end correction shall be applied in accordance with 5.3.2.2.4.

Figure 5c) shows the set-up for the measurement using anechoic termination. The measurement shall be performed in accordance with EN 25136.

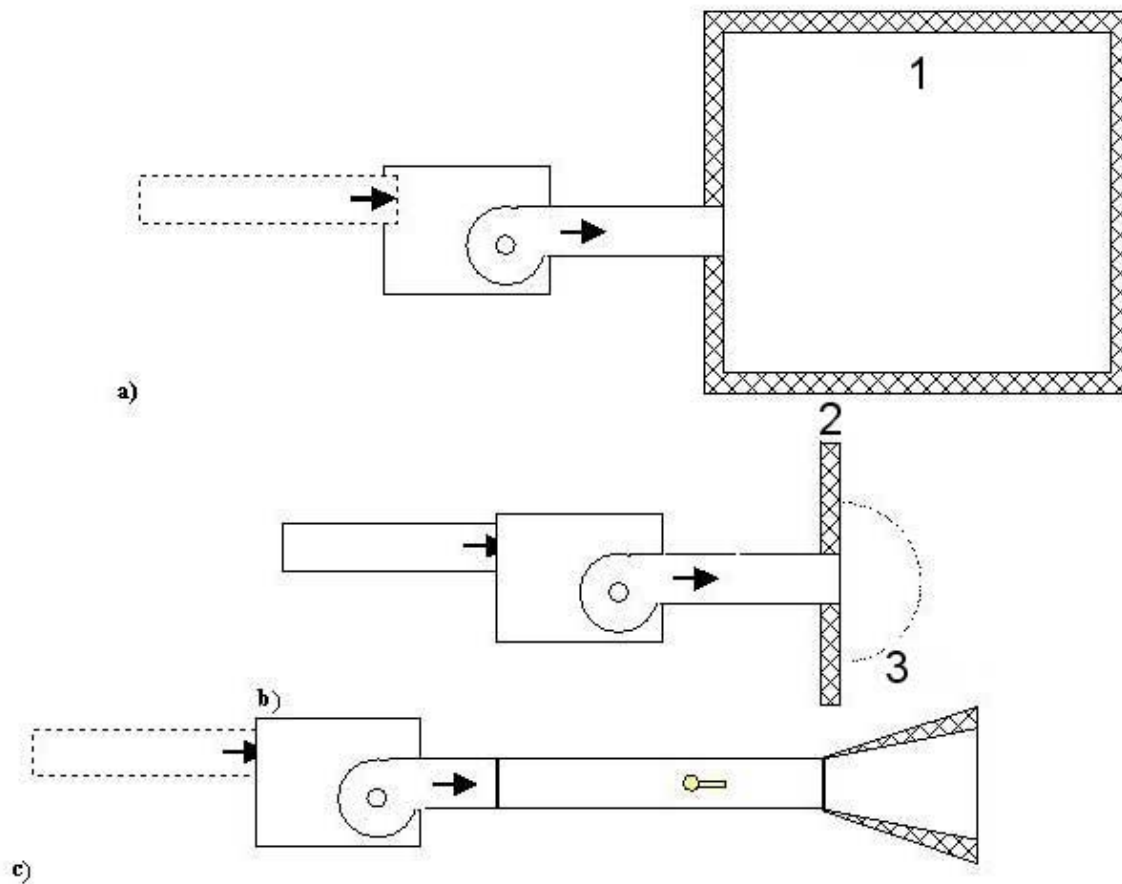

Key

- 1 Reverberation room
- 2 Baffle
- 3 Measuring surface

Figure 5 — Measurement of noise transmitted by the unit into the ductwork

5.3.2.2.2 Throttling device

Where a throttling device is necessary for adjusting the unit to the operating point it shall be positioned such that the sound pressure level generated in the test duct by the throttling device is at least 10 dB below the sound pressure level in the test duct from the unit. It is recommended to install a attenuator to reduce the influence of the noise emitted by the throttling device.

It is recommended that the throttling device is not positioned in the duct where the measurement is performed.

5.3.2.2.3 Baffle

When using free field measuring methods (EN ISO 3744, EN ISO 3746, EN ISO 9614) a baffle shall be used for the simulation of a reflecting plane (see figure 5 b)). This baffle shall be made of a high density material with a good reflection characteristic. The baffle shall be larger than the enveloping surface of measurement and it shall be large enough to provide a barrier for the sound emitted by the unit.

5.3.2.2.4 Duct end correction

The end reflection is a phenomenon that occurs whenever sound is transmitted across an abrupt change in area such as at the end of a duct in a room or in a free space. When end reflection occurs some of the sound is reflected back into the duct and does not escape into the room or space. For this reason a duct end correction shall be applied to the sound power level measured.

The calculation of the duct end correction E depends on the geometry of the duct end. For a duct terminating at a distance greater than or equal to one effective duct diameter from the reverberation room wall or baffle, the following free space equation shall be used:

$$p_{tu} = p_{tu2} - p_{tu1} \quad (3)$$

$$E = 10 \lg \left[1 + \left(\frac{c}{\pi f d} \right)^{1,88} \right] \quad (4)$$

For duct terminating flush or at a distance less than one effective duct diameter from the reverberation room wall or baffle use the following flush equation:

$$E = 10 \lg \left[1 + \left(\frac{0,8 c}{\pi f d} \right)^{1,88} \right] \quad (5)$$

where

- f is frequency, expressed in Hz;
- c is the speed of sound, expressed in air in $\text{m} \times \text{s}^{-1}$;
- d is the effective diameter of the duct, expressed in m.

and

$$d = \sqrt{\frac{4A_c}{\pi}} \quad (6)$$

where

- A_c is the duct cross-sectional area, expressed in m^2 .

This correction shall be calculated for each frequency band and added to each sound power level in each frequency band.

5.4 Tolerances

The air performance quoted or specified shall be the most probable, not the minimum or maximum acceptable value. The test for the specified duty shall be conducted in accordance with clause 16.7 of ISO 5801:1997.

The tolerance should be applied to a specified duty or duties, not to every point on the air handling unit characteristic. The characteristic is drawn from the measured data mathematically converted to the standard density $1,2 \text{ kg} \times \text{m}^{-3}$. The tolerances to define the acceptability of an air-handling unit are given in table 2.

The permissible deviation of the specified duty point from the operating point on the air-handling unit characteristic is the sum of the tolerance range of the specified duty point and the uncertainty range of the measured data. This uncertainty range derives from the measuring uncertainty of the methods of measurement and the measuring instruments and test rig used and is to be stated for a confidence level (probability) of 95 %.

For example, the departure for air volume flow is indicated in figure 6 where

prEN 13053:2003 (E)

t is the tolerance range of duty point, expressed in %;

u is the uncertainty range of measured data, expressed in %;

q_{vs} is the specified air volume flow, expressed in $m^3 \times s^{-1}$,

q_{vm} is the measured and converted air volume flow, expressed in $m^3 \times s^{-1}$,

$q_{vm} - q_{vs} = \Delta q_v \leq t \times q_{vs} + u \times q_{vm}$ is the allowable difference in air volume flow, expressed in $m^3 \times s^{-1}$.

Table 2 — Air handling unit performance tolerances

Working values	Tolerance range t	Remarks
Air volume flow q_v in $m^3 \times s^{-1}$	$\pm 5 \%$	$\Delta q_v = (t_{qv}/100 \%) \times q_v$
External total pressure difference p_{tu} in Pa	$\pm 5 \%$	$\Delta p_{tu} = (t_{\Delta p}/100 \%) \times p_{tu}$
Electrical motor input power P_E in W	+ 10 %	$\Delta P_E = (t_p/100 \%) \times P_E$ Negative deviations are permissible.
Total sound power level emitted to the ductwork and by the casing L_{WA} in dB	+ 3 dB	$\Delta L_{WA} = t_{LWA}$ The value t_{LWA} in dB is identical to the numerical value for the deviation limit for sound power level of the sound power level stated in dB(A). Negative deviations are permissible.

NOTE Uncertainties of the measured data, measuring instruments, and methods are considered in clause 16 of ISO 5801:1997 and ISO/TR 5168. An example taken from clause 16.7 of ISO 5801:1997 is given in figure 6.

5.5 Test report

The test report shall include the following information. The following list can be applied for testing any component or section, with the relevant items completed, and with additional items defined for the component or section.

- a) Date of test.
- b) Name and location of the test laboratory.
- c) Names of the test engineer and of any witness to the test.
- d) Type number and description of the air handling unit tested, including details from its rating plate.
- e) Test standard applied.
- f) Test method and configuration adopted.
- g) Description and sketch of the air handling unit and test facility used including the position(s) of damper(s) in the unit.
- h) Detailed description of the joints between the unit and the ductwork.
- i) Identification of the instruments used.
- j) Tabulations of all measured quantities and the calculated values derived from them; the acoustic data shall be supplemented by the following information: Operating point of the unit including fan speed, air volume flow, total pressure difference, duct area(s), measurement standard(s) used, description of the

test set-up. The acoustic data shall consist of the sound power levels in each octave band from 125 Hz to 8 000 Hz in dB, the overall value in dB(A) and end correction values if applicable.

- k) Tabulation of the correction for pressure difference between the measured clean filter pressure drop and that for the intermediate or final condition (if appropriate).
- l) Graphs showing the external total pressure difference and the fan electrical motor input power as functions of the air flow.

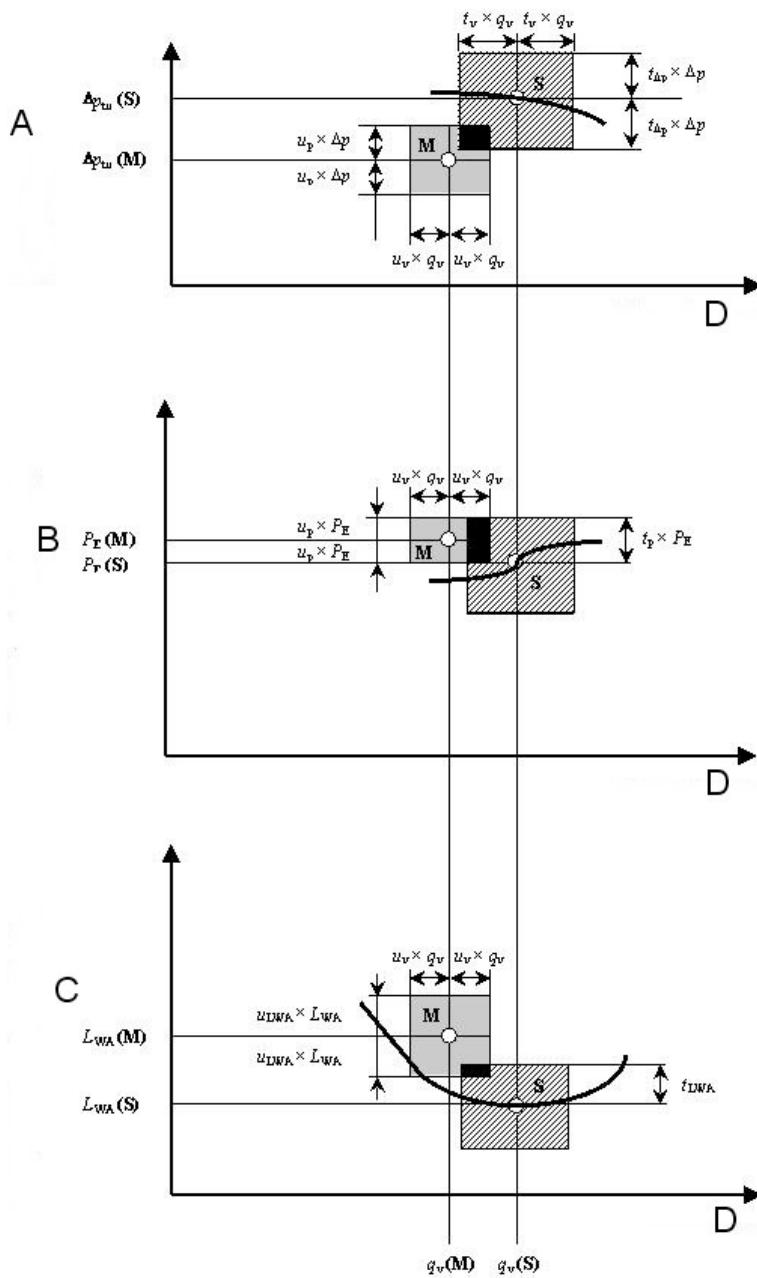

Key

- A External pressure difference of the unit ΔP_{tu}
- B Electrical motor input power P_E
- C A - weighted total sound power level L_{WA}
- D Volume flow rate q_v
- M Measuring point
- S Agreed point
- t Limit of deviation from agreed operating points
- u Measuring uncertainty of measured variable

Figure 6 — Assessment of the data measured in a performance measurement against the agreed operating points

6 Components and sections in air-handling units

6.1 General

The following paragraphs present technical requirements and test methods, which shall be applied to components and sections of complete air-handling units. However, it should be noted that the characteristics of a component or section when tested as a part of a complete air-handling unit can be significantly different from those of the same component or section tested in ideal conditions as a standalone component.

Further guidance concerning the energy performance of the air handling unit and its components and sections is presented in prEN 13779. This guidance includes examples of pressure drops for specific components in supply and extract air systems in order to achieve a certain category for fan power consumption.

Requirements and testing of defrosting arrangements of heat recovery sections are specified in annex A.

The manufacturer shall provide instructions for maintenance, including recommendations for cleaning intervals, methods, and equipment to be used.

6.2 Casing

The equipment casings shall be made from corrosion-protected and abrasion-resistant materials, which neither emit substances which are harmful to health nor form a nutrient substrate for micro-organisms. The wall structure must consist of double skin panels with sandwiched insulation. The surface of the casing shall correspond at least to the quality level, galvanised steel sheet. Sharp edges or pointed objects shall be avoided.

The ingress of unfiltered air through casing leakage can cause hygiene problems. Therefore, the casing air tightness shall comply with the requirements specified in table 2 of EN 1886.

It shall be possible to inspect, clean and disinfect all components at a justifiable technical expenditure. Therefore all equipment components shall be designed in a way that they are easily accessible and able to be cleaned from the operating side through upstream and downstream access doors or inspection panels or alternatively they shall be able to be drawn out up to an interior height of 1,6 m. The seals used shall be of a closed cell type, shall not absorb any moisture and shall not form a nutrient substrate for micro-organisms. Cleaning the equipment requires smooth surfaces inside the casing.

Weatherproof equipment shall have inlet and outlet apertures with suitable weatherproof devices which provide protection from the weather even when the air handling unit is not running. In addition, outdoor air intake chambers shall be provided with a pan (quality of floor surface minimum galvanised and coated/painted steel sheet, powder coated, or wet painted with primer and top coat of thickness $\geq 60 \mu\text{m}$ or coil coated galvanised steel sheet) with downward gradient for drainage to permit any water entering to be drained away in a controlled way, or any equivalent equipment.

To avoid water entering into the casing the following maximum air velocities are recommended, see table 3.

Table 3 — Weatherproofing / Recommended maximum air velocity

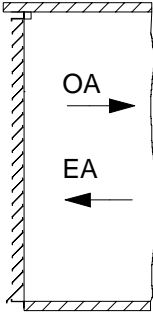
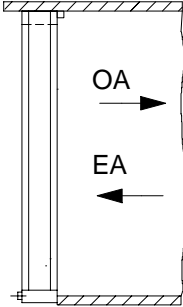
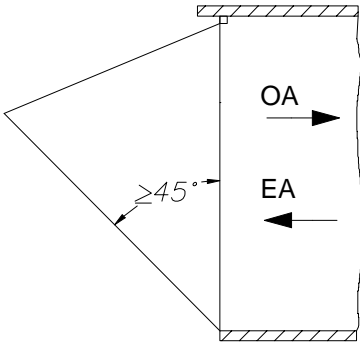
Weatherproofing		Recommended max. air velocity (with reference to the connection cross-section)	
		outdoor air side m/s	exhaust air side m/s
Louvre		2.5	4.0
Droplet eliminator		3.5	5.0
Rainhood		4.5	6.0

All apertures shall be protected by grid to prevent entry by small animals and coarse dirt (max. 20 mm × 20 mm).

Weatherproof air handling units shall not take over any static tasks or replace the function of the building roof.

NOTE 1 In cold climates it can be necessary to have a water-tight plenum section between the outdoor opening and the unit (or the first section) which guides the water immediately out of the building and/or is connected to drain.

NOTE 2 Cold bridges in cabinets introduce a risk of condensation on the inner or outer surfaces, depending on which side of the unit it is colder. The thermal bridging factor class, as defined in clause 7 of EN 1886:, should therefore be

selected to take into account the climatic conditions in which the unit is expected to operate (e.g. particularly intake air chambers, cold coolers and weatherproof units).

NOTE 3 In cold climates it can be necessary to have an additional heating facility in order to prevent a freezing of the inlet surface.

6.3 Fan section

6.3.1 General

For hygiene reasons and to reduce maintenance expenditure, it is recommend arranging supply air fans in such a way that the suction-side leakage air flows are minimised.

The arrangement of the fan in the air handling unit casing shall ensure an even in- and outflow of air. Additional inflow and outflow devices should be fitted for this purpose if necessary.

The dynamic pressures on entry and exit should be low on economic aspects. The air velocity class in the unit shall be defined according to table 4.

Fans with blades curved backwards should be provided on energy reasons. To reduce the consumption of electric power even further, energy-saving motors (e.g. class EFF1 CEMEP) with increased efficiency should preferably be fitted.

NOTE. The CEMEP, the European organisation of motor manufacturers, and the European Commission have agreed to a joint classification system for electric motors, of the efficiency of this component. The testing and design of the efficiency classes will be in accordance with EN 600 34-2.

Table 4 — Classes of air velocity levels

Class	Air velocity m/s
Class V5	No requirement
Class V4	>2,5 to 3
Class V3	>2 to 2,5
Class V2	>1,5 to 2
Class V1	max. 1,5

On energy aspects fans with backward curved blades should be provided. Starting from a interior height of 1,6 m the fan chamber shall be fitted with an inspection window (sight glass, inside diameter min. 150 mm) and with light.

A lockable maintenance switch shall be provided which shall be arranged immediately adjacent to the fan chamber.

When selecting a fan for an air-handling unit, the pressure loss allowed for filters shall be in accordance with 6.9.2, and for the cooling coil pressure loss the dry coil value shall be used unless otherwise stated. PrEN 13779 gives further information about taking into account pressure drops for other components of the air handling unit and the system.

NOTE The test methods described in clause 5 can also be applied to independent fan sections.

6.4 Coils

6.4.1 General

Coils are used for the thermodynamic treatment of air and in heat recovery systems. They shall be manufactured of corrosion-resistant materials, and the fins shall be smooth and easily cleanable.

This clause defines the requirements for coils used in air handling units. It applies to all coils, except electric heating coils.

6.4.2 Testing

Coils used in air-handling units shall be rated in accordance with EN 1216.

The capacity of the coil is determined by the enthalpy difference and the flow rate on the water side.

As a confirming method, the capacity of the coil can be determined on the air side.

As the coil under test is fitted into the air handling unit, air temperatures (dry bulb and wet bulb) shall be measured at the inlet and outlet of the air handling unit. Therefore the capacity of the heating coil measured on the air side is given as the air enthalpy difference multiplied by the air mass flow rate to which the power input to the fan is subtracted.

In a similar manner, the capacity of the cooling coil is determined by the air enthalpy difference multiplied by the air mass flow rate to which the power input to the fan is added.

The energy balance between the capacities measured on water and air sides shall not be greater than 10%.

6.4.3 Construction features

On hygiene aspects cleaning shall be guaranteed right through to the core. Therefore heat exchangers shall be designed, that they are divided in the direction of the air if necessary (the maximum fin depth shall be 300 mm per heat exchanger stage, 450 mm for aligned tubes).

On energy and hygiene aspects it is recommended that the distance between the fins of coolers that can dehumidify should be at min. 2,5 mm, otherwise the distance between fins should be at min. 2,0 mm.

Air heaters, which are used for drying before the first filter stage shall guarantee a minimum distance between the fins of at least 4 mm.

Each heat exchanger should be sealed within the casing of the air-handling unit by means of sealing strips, to avoid significant bypass leakage.

6.4.4 Cooler / Droplet Eliminator

The same requirements for drainage, cleaning, materials and disinfection apply as for humidifiers.

For cooling coils that are designed to dehumidify the following points shall be observed:

- a) No moisture carry over to the components or sections downstream of the coil.
- b) Coolers with dehumidification shall not be arranged immediately before air filters or silencers. Fans or heaters shall be installed between to limit the relative humidity.
- c) Coolers shall be fitted with a corrosion-resistant drip pan (e.g. min. AISI 316 (stainless steel 1.4301) or corrosion-resistant aluminium alloy (min. AlMg), which has a gradient towards the drain to permit unhindered drainage of condensate.
- d) The connecting pipes shall be insulated where they pass through the casing, that there will be no condensate from them.

- e) On hygienic and energy aspects, droplet eliminators should only be used if the air velocity through the cooler does not exclude drops being carried over. They shall be designed in a way that they are easy to remove and dismantle without affecting any of the other unit components.
- f) It shall be possible to clean the cooling coil from both sides in mounted position, or alternatively up to an internal height of 1,6 m, it shall be removable for cleaning purposes.
- g) On corrosion-resistance aspects, a collector of copper is recommended in case of copper / copper or copper / aluminium execution. If galvanised steel coolers are used, hot dip galvanising is recommended.

6.5 Heat recovery sections

6.5.1 General

Air handling unit's with supply and extract air should be fitted with heat recovery systems. When positioning heat recovery equipment, care shall be take about minimised air leakage and unacceptable recirculating air flows.

To reduce the need for the use of mechanical cooling in summer, it is recommend as an addition to heat recovery that evaporation cooling should be installed on the extract air side. The necessity for a condensate pan should be examined. If a condensate pan is necessary the relevant requests (see 6.4.3) are to be kept.

6.5.2 Classifications and requirements

This standard is applicable to the following categories of heat exchangers, as defined in EN 308:

Category I	Recuperators
Category II	With intermediary heat transfer medium <ul style="list-style-type: none"> * Category IIa - without phase-change * Category IIb - with phase-change (heat-pipe...)
Category III	Regenerators (containing accumulating mass) <ul style="list-style-type: none"> * Category IIIa - non-hygroscopic * Category IIIb - hygroscopic

All heat exchangers shall be fitted with seals to minimise air leakage, see EN 308. HVAC-systems with supply and exhaust air should be fitted with heat recovery units. The minimum dry heat recovery efficiency (with reference to the mass flow ratio 1:1) and the maximum pressure losses are based on the annual running time of the system and the maximum outdoor air flow necessary in winter operation, see table 5.

Table 5 — Heat recovery figures and pressure losses depending on the operating hours per air side

Pressure losses Pa	Efficiency %	Air volume flow $m^3 \times s^{-1}$				
		0,55 to 1,39	> 1,39 to 2,78	> 2,78 to 6,94	> 6,94 to 13,89	> 13,89
Operating hours h/a	< 2 000	-	0,40	0,43	0,50	0,55
	\geq 2 000 to 4 000	0,40	0,43	0,47	0,53	0,58
	> 4 000 to 6 000	0,43	0,45	0,50	0,58	0,63
	> 6 000	0,45	0,50	0,55	0,63	0,68
		-	150	175	200	225
		175	200	225	250	275
		200	225	250	275	300
		225	250	275	300	325

The pressure losses apply accordingly to supply and respectively exhaust air. Proof of performance shall be undertaken in accordance with EN 308. Higher pressure loss percentages for higher heat recovery figures. Table 6 defines classes of heat recovery efficiency and pressure drop according to table 5.

Table 6 — Classes of heat recovery efficiency and pressure drop based on table 5

Class	Efficiency %	Pressure drop Pa
Class H5	No requirement	No requirement
Class H4	Value x 0,8	Value x 1,2
Class H3	Value x 0,9	Value x 1,1
Class H2	Value as table 3	Value as table 3
Class H1	Value x 1,1	Value x 0,8

To reduce the need for the use of refrigeration in summer, we recommend as an addition to heat recovery that evaporation cooling should be installed on the exhaust air side.

Requirements for heat exchangers according to this standard are as follows:

- a) all heat recovery sections shall have 4 pressure tapping points, one on each air flow side of the exchanger;
- b) all heat exchangers shall be fitted with seals to minimise air leakage;
- c) within heat recovery sections fitted with category I and II heat exchangers there shall be a drain pan for condensate;
- d) category III heat exchangers shall include a purge sector, except when recirculation air is used.

6.5.3 Testing

The heat recovery device shall be rated in accordance with EN 308. Where relevant the ability to function at low outdoor temperatures and the effectiveness of defrosting arrangements shall be tested in accordance with annex A.

The risk of frosting and the need for testing the defrosting arrangement shall be established by calculations which take into account air flows, including the balance between supply and extract air flow, type and temperature ratio of the heat exchanger, outdoor air temperature and extract air temperature and humidity.

6.6 Damper sections

6.6.1 General

Air regulating and shut-off dampers shall correspond to EN 1751. The face velocity shall be limited to $8 \text{ m} \times \text{s}^{-1}$ (exception: recirculation air and bypass dampers). On energy and function aspects, an inflow angle of min. $\alpha = 25^\circ$ and an outflow angle of min. $\beta = 35^\circ$ is recommended (see figure 7).

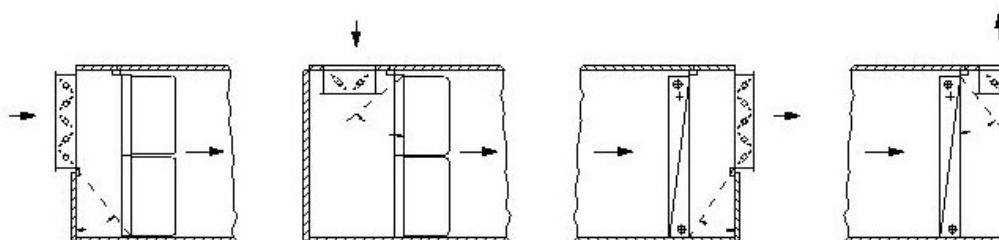

Figure 7 — Inflow and outflow angle

6.6.2 Classification

The characteristics of dampers shall be classified in accordance with EN 1751.

6.6.3 Requirements and testing

For all dampers which are intended to be closed completely during operation, e.g. bypass dampers for heat recovery sections and recirculation dampers for mixing section, the air tightness for the damper in closed position shall meet the air tightness requirement of class 2 in accordance with EN 1751:1998. For installations with high requirements for hygiene or energy economy, supply air and exhaust air-dampers, shall meet the air tightness requirement of class 3.

6.7 Mixing sections

6.7.1 General

This clause specifies the requirements and testing methods for standard mixing sections used in air-handling units to mix and control air flows with different temperatures, primarily exhaust air with outdoor air, in order to recirculate it in the building.

6.7.2 Categories and characteristics

6.7.2.1 Category A. On-off sections, operating only in certain conditions (e.g. night heating)

Where the function utilises 100 % outdoor/exhaust air or 100 % recirculated air, the characteristics to be specified are as follows:

- tightness of recirculation air damper;
- uniformity of flow after the mixing section or minimum distance to specified sections;
- pressure drop of dampers for calculation of difference of volume flows in "recirculation" and "closed" positions.

6.7.2.2 Category B. Sections for flow control

Where the function utilises control/mixing air flows, the characteristics to be specified are as follows:

- damper tightness, uniformity of flow after the mixing section or minimum distance to downstream sections sensitive to non-uniform flow;
- mixing characteristics according to 6.7.3;
- temperature gradient (stratification);
- risk of freezing;
- risk of condensation;
- pressure drop of dampers for calculation of difference of volume flows in different positions.

6.7.3 Requirements

6.7.3.1 General

The mixing section can have a major influence on the air flows and pressure balance within the ventilation or air conditioning system and hence the building. The quality of mixing is characterised by the temperature mixing efficiency specified in 6.7.3.2.

The mixing efficiency shall be measured at recirculation flow damper positions 90 % open, 50 % open, and 20 % open.

For the assessment of the lowest or highest possible air temperature immediately downstream the mixing section, the mean temperature of the mixed flow can be derived from the quantities of outdoor and recirculated air flows in accordance with formula (7).

The cross sectional areas, temperatures, velocities and densities are as shown in figure 8. Subscript "H" refers to the higher temperature air flow, "L" refers to the lower temperature air flow and "tot" to the air flow downstream of the mixing section.

$$t_M = \frac{t_H \cdot \rho_H \cdot q_{vH} + t_L \cdot \rho_L \cdot q_{vL}}{\rho_{tot} \cdot q_{vtot}} \quad (7)$$

The mean velocity is calculated using formula (7)

$$V_M = \frac{q_v}{A_{tot}} \quad (8)$$

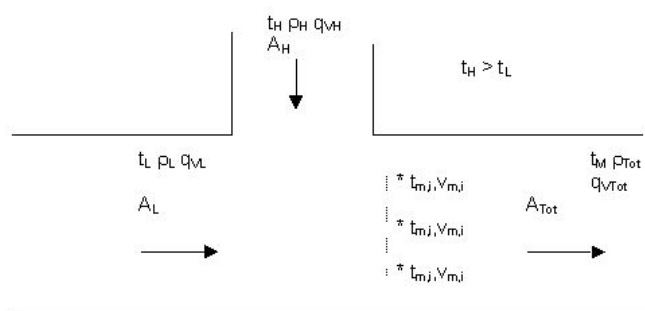

Figure 8 — Quantities to define mixing efficiencies

6.7.3.2 Temperature mixing efficiency

Measure the temperatures and velocities downstream of the mixing section according to 6.7.4 (see figure 8).

The temperature mixing efficiency is calculated from formula 9

$$\eta_{\text{mix}} = \left(1 - \frac{t_{\text{max}} - t_{\text{min}}}{t_{\text{H}} - t_{\text{L}}} \right) \times 100 \% \quad (9)$$

where

- η_{mix} is the mixing efficiency, expressed in %;
- t_{max} is the highest temperature in the measuring plane downstream the mixing section, expressed in °C;
- t_{min} is the lowest temperature in the measuring plane downstream the mixing section, expressed in °C;
- t_{H} is the higher temperature of entering air, expressed in °C;
- t_{L} is the lower temperature of entering air, expressed in °C.

The classification of mixing temperature efficiency is given in table 7

Table 7 — Mixing temperature efficiency

Class	Mixing efficiency %
M1	≥ 95
M2	85 ≤ η < 95
M3	70 ≤ η < 85
M4	50 ≤ η < 70
M5	< 50

6.7.3.3 Uniformity of flow after the mixing section

The uniformity of flow after the mixing section is calculated from formula (10).

NOTE Because of the often very uneven and turbulent air flow immediately downstream of the mixing section, velocity measurements at these points may be very inaccurate and the results should be used only as a rough estimate of the velocity profile.

$$\frac{v_{\min}}{v_m} \leq U \leq \frac{v_{\max}}{v_m} \tag{10}$$

where

- U is the range of uniformity of flow; bounded by lower and upper ratio of minimum and maximum velocity to mean velocity;
- v_{\min} is the lowest velocity on a grid at the end of the mixing section, expressed in $m \times s^{-1}$;
- v_{\max} is the highest velocity on a grid at the end of the mixing section, expressed in $m \times s^{-1}$;
- v_m is the calculated mean velocity in the cross section at the end of the mixing section, expressed in $m \times s^{-1}$.

6.7.4 Measurements

This method is applicable for rating purposes of standalone mixing sections under laboratory conditions. For field tests, which are not applicable for rating purposes, see 6.7.5. The efficiency in a real air-handling unit depends also on the configuration of the whole unit and how it is connected to the system.

6.7.4.1 Measurement of air temperature

Air temperatures shall be measured on a grid at the end of the mixing section, just upstream of the position where a defined mixing quality shall be available. At least 3 temperature measuring devices should be installed equispaced in the vertical and horizontal directions of the grid. The distance between the casing and the nearest temperature measuring devices should exceed 25 mm, and the distance between adjacent temperature measuring devices should not be less than 100 mm but not more than 300 mm.

The distance between the casing and the nearest measuring points should be half the distance between the next points. For rating purposes, the temperatures of the two incoming air flows to be mixed shall differ by more than 25 K.

6.7.4.2 Measurement of air velocity

The local air velocities shall be measured at the same points as the temperatures, using probes with directional sensitivity to measure only axial velocity components in the grid.

Pitot static tube measurements in combination with high sensitive micromanometers meet this requirement.

6.7.4.3 Measurement of air flows

Air flow measurement shall be made on each side of the mixing section. Methods in accordance with ISO 5167-1, ISO 3966 or ISO 5801:1997 shall be applied.

6.7.5 Field testing of mixing efficiency

Field tests are often needed to check the functioning of the mixing section in real installations, e.g. during commissioning, during periodical inspections of the system or when an existing air handling unit is modified by adding new sections or components. A field test is not valid for rating purposes.

NOTE When the temperature difference between the two air flows is lowered, the accuracy of the field testing of temperature mixing efficiency is decreased. It is recommended to do the field test at as high a temperature difference as possible. When the temperature difference is less than 10 K, only the grade of uniformity should be reported.

6.8 Humidifiers

6.8.1 General

Air humidification sections shall be operable in such a way that they do not cause any hazard to health. The selection of the materials to be used in the humidifier shall be made taking account of corrosion-resistance, hygiene, bacteriostatic or bactericidal surface effect, ability of microbes to metabolise the material, resistance to disinfectants, ability to be cleaned and, if applicable, resistance to the respective disinfection process. The plastics used shall not contain sources of nutrition for microbiological growth.

For air handling units with supply air humidifiers (exception: steam humidifiers) it is recommended to be equipped with at least two filter stages, whereby the humidifier is to be arranged between the first and second filter stage. Humidifiers (exception: steam humidifiers) shall not be arranged immediately before air filters or attenuators. The first filter stage shall be F7 on hygiene aspects. The sealing materials used shall be made of a closed cell type and shall not absorb any moisture.

Only humidifier water containing bacteria in a concentration that is not detrimental to health is used for air handling purposes. If it is suspected to contain more bacteria, the humidifier water shall be checked for pathogenic bacteria.

The upper limit value for non-pathogenic bacteria is $10\,000 \text{ cfu}^1) \times \text{ml}^{-1}$. However, from a bacteria content of $1\,000 \text{ cfu} \times \text{ml}^{-1}$ onwards in the humidifier water, the plant should be checked and cleaned.

The manufacturer's maintenance instructions shall be available and observed.

In the case of humidifiers operating with recirculating water, from the point of view of reducing the number of bacteria, the dissolved solids content, and the dirt particles, it is better to empty the tray completely rather than to bleed off continuously.

Disinfectants can be used during cleaning after all the accumulated dirt has been removed.

Sufficient overflow shall be arranged in evaporative humidifiers. Ultraviolet treatment and regular flushing are recommended.

1) cfu means colony forming unit

6.8.2 Categories

Humidifiers are categorised according to type of construction as follows:

- spray humidifiers: A: air washers
 B: ultrasonic humidifiers
 C: high-pressure atomisers
- evaporative humidifiers: D: contact humidifiers
- steam humidifiers: E

6.8.3 Requirements

6.8.3.1 Droplet impingement on downstream components

In order to avoid droplets impinging on components downstream of the humidifier, the length of the humidifier section shall be sized accordingly, and/or suitable components for the separation of water (e.g. droplet eliminators) shall be installed.

6.8.3.2 Surface finish of the humidifier casing

Examples of surface materials for humidifier casing are as follows:

Categories A, C: inside stainless steel or corrosion-proof aluminium (min. AlMg) or resin coated glass fibre.

Categories B, D, E: inside steel sheet, galvanised and coated (powder coating or two-coat wet painting with priming and finishing coats, min. 60 µm) or galvanised steel sheet and strip-coated.

6.8.3.3 Constructional details

The requirements for construction for different categories are specified in table 8.

Table 8 — Constructional details for different humidifiers

Item	Requirements	Humidifier category
1	Humidifier parts easily accessible through inspection door or panel for cleaning and maintenance purposes	A to D
2	Built-in parts such as droplet eliminators, nozzles and pipes dismountable	A to E
3	All water-carrying parts corrosion proof	A to E
4	Tray made of corrosion proof materials, e.g. stainless steel or aluminium (min. AlMg)	A to E
5	Tray with all sides sloped, completely drainable	A, C, D
6	Porthole (min. diameter 150 mm) and internal light	B to E

Table 8 (continued)

Item	Requirements	Humidifier category
7	Inspection window (min. diameter 150 mm) with blind, and internal light (min. IP 65). Completely emptied and dried automatically (dry running device). Where lighting is fitted externally, care shall also be taken that when the light is switched off, no light can penetrate into the humidification chamber.	A
8	Dry-running protection device for pump	A, C, D
9	If the use of disinfection processes is necessary to avoid the growth of germs, only methods should be used, the effectiveness of which has been proved in practice and which have been proved to be safe as regards health. Disinfectants shall not get into the room air through the humidification process.	A to E
10	Automatic bleed / sludge removal device	A, D
11	Interior casing watertight at negative pressure and positive pressure	A, C

6.8.4 Testing of adiabatic humidification

For efficiency testing of adiabatic humidification systems the following physical dimensions are to be measured:

- air volume flow rate (q_v)
- mass flow of water inlet (q_w)
- mass flow of water drain and overflow (q_d)
- mean air temperature before the entrance of the humidifier (t_1)
- mean air temperature after the humidifier (t_2)
- wet-bulb temperature (saturation) (t_3)

The efficiency of humidification η_h is determined as follows:

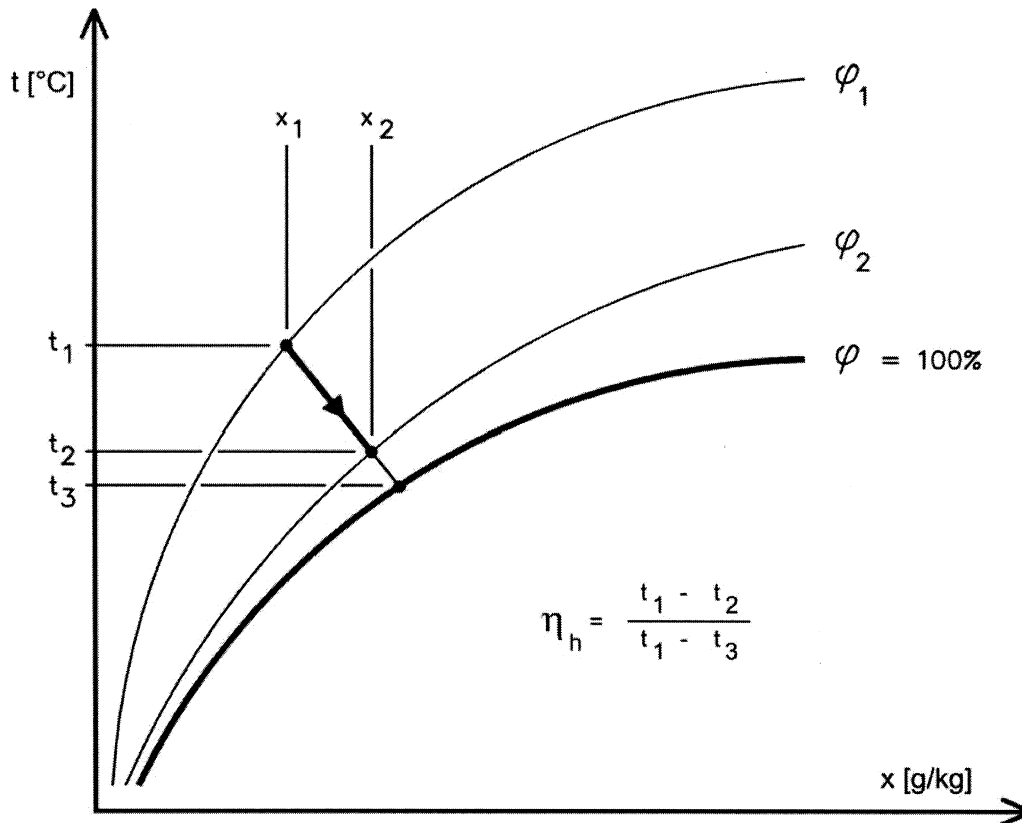

Figure 9 — Humidifier efficiency

In order to achieve a sufficient measuring accuracy the temperature difference between the air temperature before the entrance of the humidifier t_1 and the wet-bulb temperature t_3 should be at least 10 K. If necessary air is to be heated before entrance in the humidifier.

Under the test conditions the balance between humidifier efficiency q_{hv} measured on the air side and the water side q_{hw} shall not be greater than 5%.

$$q_{hv} = q_v \cdot (x_2 - x_1) \tag{11}$$

$$q_{hw} = q_w - q_d \tag{12}$$

where

q_v is the air volume flow rate, expressed in $\text{m}^3 \times \text{s}^{-1}$;

q_w is the mass flow of water inlet, expressed in $\text{kg} \times \text{s}^{-1}$;

q_d is the mass flow of water drain and overflow, expressed in $\text{kg} \times \text{s}^{-1}$.

6.9 Filter sections

6.9.1 General requirements

The task of air filters in HVAC systems is not only to protect the ventilated rooms from too severe a level of contamination but also the HVAC system itself. This is guaranteed by the use of fine filters of filter class F5 to F9 according to EN 779. When manufacturing air filters, no components or materials may be used which can serve microbes as nutrients.

The requirements for air tightness, strength, and bypass leakage are specified in EN 1886.

The side wall on the service side of the filter section shall be equipped with an inspection door. The width and height of the door shall be greater than the external dimensions of the replaceable filter elements. There shall be a free space to the side of the access door, and immediately upstream of front access filters, sufficient to allow unrestricted access for filter removal and replacement.

The filter section shall be equipped with tapings for a pressure loss gauge/ manometer.

Additional requirements can be specified which take into account the climatic conditions (e.g. low temperatures, moisture, sand, and salt mist).

NOTE In cold climates the possible accumulation of rime may require the slight preheating of supply air, and where there is excessive mist in outdoor air the moisture running off the filters can necessitate specific requirements for corrosion protection.

6.9.2 Filters installed in air handling units

The first filter stage is to be fitted on the intake side, as close as possible to the outer air intake aperture to keep the air treatment elements as clean as possible. Additional coarse filters G1 to G4 are permissible. The second filter stage is arranged on the output side at the beginning of the supply duct in order to keep the ductwork clean.

If a single stage filter system is used, a minimum of filter class F7 shall be fitted.

If two-stage filtering is used, the supply air fan shall be arranged between the first and second filter stage. To avoid microbial growth on air filters of the second or higher filter stage, the relative humidity in the area of the filter is to be limited to 90% (dropping below the dew point in the area of the air filter shall always be avoided). Air filters shall not be arranged immediately after coolers with dehumidification or after humidifiers (exception – steam humidifiers).

If bag filters are used, the filter area shall be at least 10 m² per 1 m² equipment cross-section. The seals used shall be of a closed cell type, shall not absorb any moisture and shall not form a nutrient substrate for micro-organisms. A permanent tight fit shall be guaranteed for the seal (e.g. operation from the dusty air side). Starting from a interior height of 1,6 m the fan chamber shall be fitted with an inspection window (sight glass, inside diameter min. 150 mm) and with light.

For fan selection purposes the filter pressure loss value at design volume flow shall be the average of the initial and final pressure losses for clean and dust loaded filters, respectively.

NOTE 1 Variation in volume flow caused by the accumulation of dust should be given in technical specifications. If specific tolerances for an application are not specified, $\pm 10\%$ based on the average pressure drop is acceptable.

The pressure loss of a filter section loaded with dust shall not exceed the values given in table 9. Lower final pressure drops can be also specified where appropriate.

Filters installed in air handling units used for human occupancy shall be tested and classified according to EN 779.

Table 9 — Maximum final pressure drop for filters

Filter class	Final pressure drop
G1 - G4	150 Pa
F5 - F7	200 Pa
F8 - F9	300 Pa

NOTE 2 The final pressure drops tabulated in table 8 are typical maximum values for air-handling units in operation and lower than those used in EN 779 for classification purposes, for reasons of energy saving, and the performance obtained from tests according to EN 779 are not necessarily met at these lower pressure drops.

The following data shall be displayed in a clearly visible form (e.g. label) on the filter section: filter class, type of filter medium, final pressure drop. On changing the filter, the user shall check and update this information.

6.10 Sound attenuation sections

The performance of sound attenuation sections shall be tested according to EN ISO 7235.

Attenuators should be placed immediately adjacent to the source generating the noise to reduce noise emissions and should therefore preferably be installed in the air handling unit immediately before and after the fan. On hygiene aspects they shall not be arranged immediately after coolers with dehumidification or other humidifying devices.

To ensure unhindered in- and outflow, a minimum distance from other installed components of 1,0 x (inflow) and/or 1,5 x (outflow) max. splitter thickness shall be provided. The individual splitters shall be able to be removed for cleaning and shall consist of permanently abrasion-resistant material which is safe from a health point of view. No fibres shall be loosened during service. The use of inflow cups can reduce the pressure drop.

7 Extended hygiene requirements for special applications

7.1 General

Air handling units with high hygiene requirements (e.g. hospitals, clean rooms, pharmaceutical industries etc.) shall also meet the requirements defined in this clause.

7.2 Accessibility

The components of air handling units shall be accessible for cleaning purposes, through access doors both upstream and downstream, or alternatively they shall be easy and safe to remove.

7.3 Smoothness

Any half-closed profiles or joints that can accumulate pollutants and dirt, and are difficult to clean, shall not be accepted, especially in the cabinet floor. All fibrous and porous material, except replaceable components like filter cells, shall be protected by suitable smooth material, which can withstand frequent cleaning. Screws and other similar components shall not protrude from the internal walls.

7.4 Inspection windows and lights

All units shall be provided with inspection windows and internal lighting for checking at least the fans, filters, and humidifiers.

7.5 Drainage/prevention of condensation, humidifiers

For evaporative humidifiers a continuous overflow shall be arranged. Ultraviolet treatment and regular flushing are recommended.

For non-pathogenic bacteria contained in the humidifier water used for air handling purposes, the upper limit value is $1\,000\text{ cfu} \times \text{ml}^{-1}$. However, from a bacteria concentration of $100\text{ cfu} \times \text{ml}^{-1}$ onwards in the humidifier water, the plant should be checked and cleaned.

It is reasonable to use ultraviolet sterilizers for reducing the number of bacteria. When designing and adjusting them, however, care shall be taken that no ozone is generated and enters the served space.

Biocides can only be used if, under no circumstances, they are detrimental to the health of the occupants in the areas served by the air-handling unit.

7.6 Air leakage

The casing air leakage shall not exceed class L2 according to EN 1886.

8 Instructions for installation, operation and maintenance

8.1 Installation

The air-handling unit should be installed according to the manufacturer's instruction.

The instructions for installation and commissioning should be in accordance with existing standards, codes, and rules. The instructions should include information about the space required for maintenance, mounting and supports etc., preferably including detailed drawings and/or technical data. Connections to water, drainage, and the electrical supply network should also be presented in detailed drawings. The unit should be easy to connect into those networks and also easy to remove if service or repair is needed.

Air handling units shall be equipped with suitable lifting devices such as crane eyes, wood or pallets for transportation by crane or forklift.

Components at risk, e.g. fans on spring insulators, shall be protected by safety devices during the transportation. A label should be attached to the unit stating that such devices shall be removed on installation.

Particularly sensitive components or attachments in the area of divisions between pieces of equipment shall be protected from damage by suitable measures (e.g. freely accessible fin packages of heat exchangers should be completely covered).

8.2 Operation and maintenance

Instructions for operation and maintenance should include:

- instructions for safe use in service and maintenance;
- instructions for starting and closing down the equipment;
- instructions for monitoring equipment and instrumentation, periodical inspections, recommendations for inspection intervals;
- description of normal operation of the unit, instructions concerning protection and control equipment, instructions for fault finding;
- service and cleaning instructions including drawings. For components which require periodical service or change, an estimated service schedule and a list of spare parts and accessories are required;

— estimated schedule for periodical inspections.

For each functional section of the air-handling unit, appropriate instructions for operation and maintenance are required.

8.3 Documentation and labelling

Air handling units shall have permanently attached type plates with permanent labelling.

In addition to the manufacturer, type and order number, all the necessary technical data shall also be clearly shown. A drawing of the unit with all the main and duct connection dimensions, a design data sheet, a spare part list plus assembly, commissioning and maintenance instructions shall be supplied with air handling unit.

Annex A (normative)

Air handling units - Heat recovery – Defrosting - Requirements and testing

A.1 General

This annex covers the laboratory testing of the correct functioning and the energy recovery of air-handling units with air-to-air heat exchangers of category I or II according to EN 308 under conditions where frosting can occur. The tests are performed at specified duty points and the result can be used for comparisons and for calculations of recovered heat during a longer period, normally one year.

NOTE For testing air-to-air heat exchangers, EN 308 describes a method for laboratory testing of leakage, pressure drop and temperature ratio. However, in cold climate heat exchangers of category I and II often can have frosting problems. Due to the fact that defrosting is a matter of, not only the heat exchanger itself, but also the whole air handling unit, this annex specifies a method for testing the defrosting and frost protection arrangements for air-handling units. Frosting can occur at low outdoor temperatures when moisture is added to the air in the building. The loss of recovered energy can be considerable. The type of heat exchanger, efficiency, and exhaust air temperature can also influence the amount of frosting problems. For cross-flow heat exchangers these problems typically occur at outdoor temperatures lower than -5 °C when moisture is added to the air, not only by the emission from human beings but also due to activities and processes such as, cooking, washing and drying.

A.2 Defrosting

A.2.1 Defrosting heat ratio

$$\varepsilon_D = \frac{\sum_{i=1}^k [q_{m22,i} - c_{p2} - (t_{22,i} - t_{21,i}) \Delta \tau_i] - Q_{\text{defr}}}{q_{m11} \sum_{i=1}^k c_{p1} - (t_{11,i} - t_{21,i}) \Delta \tau_i}$$

where

ε_D is the defrosting heat ratio;

k is the number of measurements within the total measuring time;

$\Delta \tau$ is the sampling interval time, expressed in seconds;

Q_{defr} is the total energy input for defrosting during one complete frosting/defrosting cycle, expressed in joules.

A.2.2 Non-cyclic defrosting

The unit is provided with a continuously working defrosting function, which stabilises or avoids frost formation. The static pressure difference on the exhaust air side remains unchanged.

A.2.3 Cyclic defrosting

The unit allows for frost formation followed by a defrosting period. This results in a cyclic increase/decrease of pressure difference on the exhaust air side.

A.3 Testing

A.3.1 Test rig

The complete air-handling unit shall operate with its own fans and be installed with external ducts to ensure that the defrosting equipment acts in a similar way to a real installation. The total external pressure drop shall be 250 Pa at nominal air flow on both supply air side and exhaust air side. The pressure loss coefficient of the external parts of the test rig shall be constant during the test, so that only frosting can influence the air flow. Ambient temperature should be 20 ± 3 °C. (See figure A.1.)

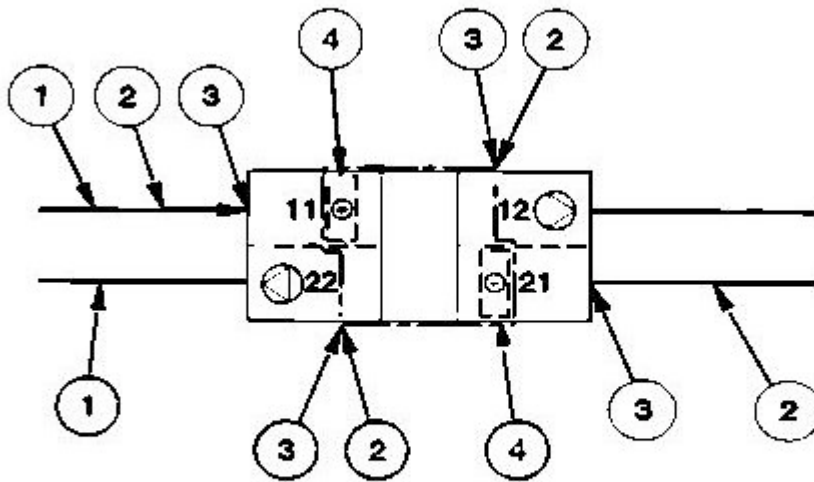

Key

- 1 Measurement of air flow
- 2 Measurement of static pressure
- 3 Measurement of temperature
- 4 Defrosting energy
- 11 Exhaust air in
- 12 Exhaust air out
- 21 Supply air in
- 22 Supply air out

Figure A.1 — Test arrangement for defrosting test

A.3.2 Duty points

Heat recovery performance shall be determined for the following two duty points:

Air flow

NOTE 1 These are the initial air flows. Both air flows may vary during the measurement time.

Supply air $q_{m2} = q_{mn}$

Exhaust air $q_{m1} = q_{mn}$

Temperature and humidity

Exhaust air inlet + 20 °C, 30 % relative humidity

Supply air inlet 1 - 7 °C

Supply air inlet 2 -15 °C

NOTE 2 Special applications, e.g. high exhaust air humidity, other duty points should be considered.

Sampling for performance test shall be done during a number of complete defrosting cycles. Total test time shall include at least 3 cycles and minimum test time shall be 6 hours. For non-cyclic defrosting, sampling shall be done under steady state conditions. This condition is reached when temperatures are stable and the heat exchanger exhaust pressure drop, Δp_1 , does not vary more than 5 % from the mean value during test.

Functioning of the defrosting equipment shall be controlled at the same duty points. When testing a cyclic defrosting arrangement the variation of pressure drop Δp_1 between different cycles shall not exceed 5 %. Non-cyclic systems can be considered to meet the requirements if they become stable under operating conditions.

A.3.3 Test procedures

Where appropriate and not otherwise stated, EN 308 shall apply. In addition to the applicable requirements in EN 308, the test shall be in accordance with the procedures given in A.3.4 and A.3.5.

A.3.4 Testing of defrosting heat ratio

The mean value of the temperatures in both sections, t_{11} and t_{21} , shall be adjusted to within 1 °C of the given temperature in A.3.2 during the test. The maximum deviation shall be within 1,5 °C from the mean value during the test.

Any energy input for defrosting shall be taken into account for calculation of defrosting ratios. The temperatures of the air flows, defrosting energy and pressure drop shall be measured continuously during the test. The sampling interval should not exceed 60 s.

A.3.5 Total measuring time

For non-cyclic defrosting the measuring time after reaching steady state condition shall be 30 min.

For cyclic defrosting the total measuring time shall be a minimum of three cycles, according to figure A.2.

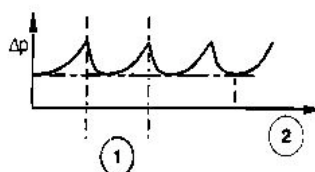

Key

- 1 Measuring time
- 2 Time s

Figure A.2 — Measuring time for cyclic defrosting

A.4 Test report

A.4.1 The heat recovery device

A description shall be made of defrosting arrangement. Any adjustment of parameters to control defrosting such as time and temperatures shall be clearly stated in the report.

A.4.2 The defrosting heat ratio

The following parameters shall be presented:

- The nominal value of the parameters at the beginning of the test, the mean value of the parameters, and diagrams showing the parameters as a function of time during the test:

q_{m1}	q_{m2}	t_{11}	t_{21}	ε_D	Q_{defr}	Δp_1
$\text{kg}\cdot\text{s}^{-1}$	$\text{kg}\cdot\text{s}^{-1}$	$^{\circ}\text{C}$	$^{\circ}\text{C}$	%	W	Pa

- The total measuring time.
- The cycle time.